



Area and Perimeter Mixed Questions

1. Calculate the area. 27 cm^2



2. Calculate the perimeter. 20 mm



3. Calculate the area. 144 m^2

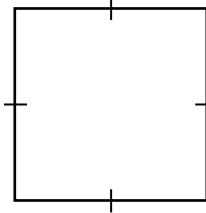

4. Calculate the perimeter. 22 cm

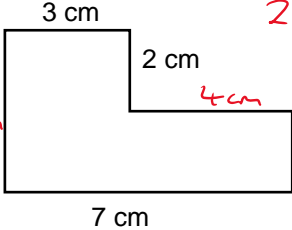

5. Calculate the area. 194 mm^2

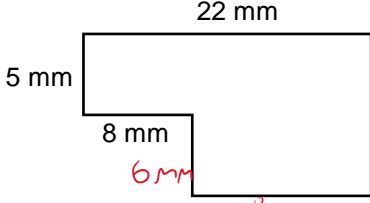

6. Calculate the area. 24 cm^2

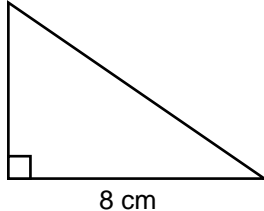

7. Calculate the perimeter. 12 m

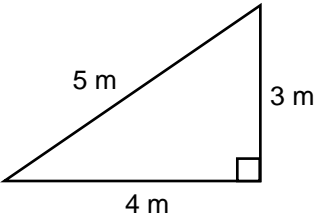

8. Calculate the area. 15 cm^2

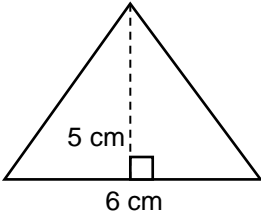

9. Calculate the area. 30 cm^2

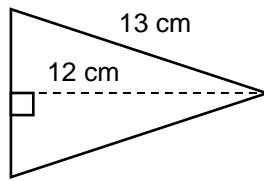

10. Calculate the area. 96 mm^2

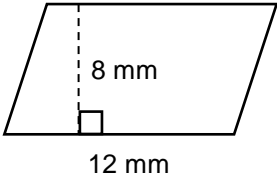

11. Calculate the area. 35 cm^2

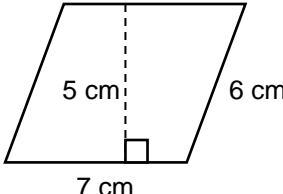

12. Calculate the perimeter. 26 cm

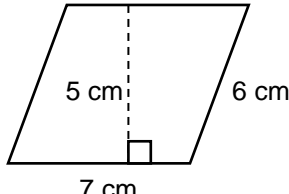

13. Calculate the area. 25 cm^2

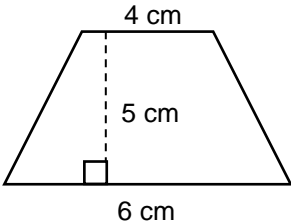

14. Calculate the area. 6 m^2

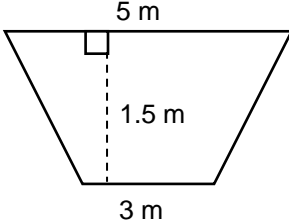

15. Calculate the perimeter. 22 cm

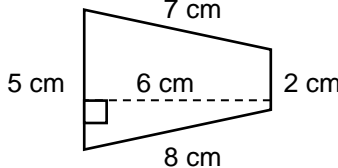

16. Calculate the area. 21 cm^2

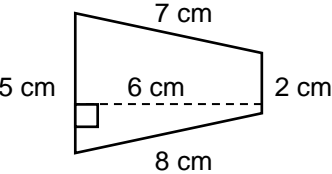

17. Calculate the area. 30 mm^2

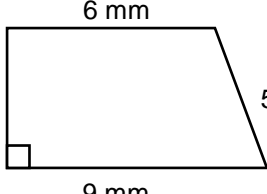

18. Calculate the perimeter. 45 cm

